

Presentation

Part Number: WM 555.6041

**Block of 4 small drawers height 80 mm
(compatible only with Medium and Heavy Duty WorkiMed Carts)**

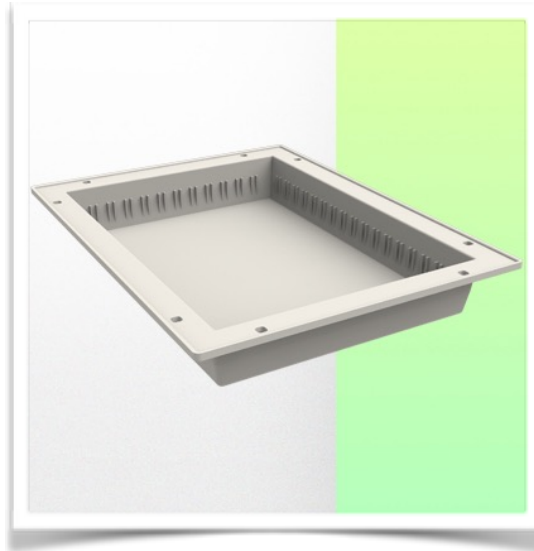

This telescopic drawer unit is fixed to the base of the medical trolley column with the included column rail adapters. It will allow you to store medical consumables.

On top of the drawer is a 490 x 300 mm work surface which improves the working space.

Inside the drawer is a 40 x 30 x 5 cm ISO tray which allows the drawer to be partitioned to improve product storage. Dividers can be supplied as an option.

The internal dimensions of the drawer are W 420 x D 397 x H 80 mm

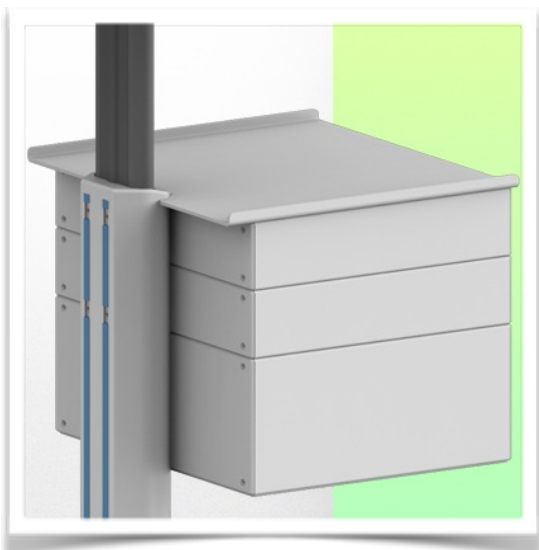

Presentation

Part Number: WM 555.6041

Block of 4 small drawers height 80 mm
(compatible only with Medium and Heavy Duty WorkiMed Carts)

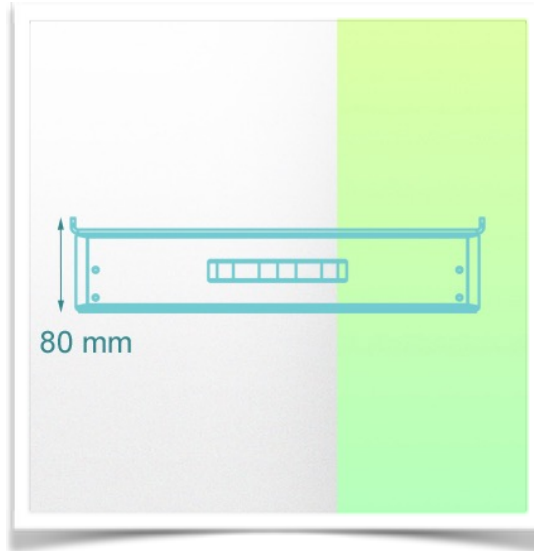
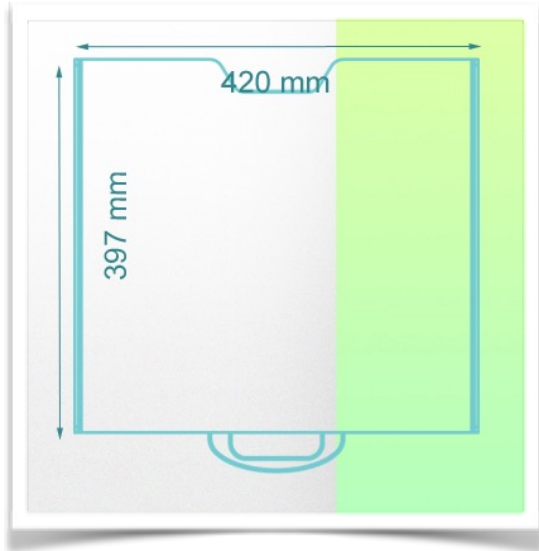

Mechanical data

Internal dimensions 420 x 397 x 80 mm

Max load per drawer

5 Kg

Construction

Material: Aluminium

Colour

RAL 9016 White / Aluminium

